



Pergolas
collection

sevensun

100% HELLENIC SHADE.

Pergolas collection

Index

BIOCLIMATIC PERGOLAS

Bioclimatic pergolas	06
Biopergosun	10
Biopergosun wall	18
Biopergosun roof	24

PERGOLAS

Pergosun	28
----------	----

ACCESSORIES

Heatscope	36
Automations	38
Performance and certifications	39

100% hellenic shade

Sevensun was founded in Athens, Greece in 2012. Driven by passion and constant innovation, we grew rapidly to become a leading manufacturer of high-spec shading solutions. This is our one and only field of business, and we make sure that we excel at it across the board.

All of our products & components are designed and built in-house in our own facilities under the strictest of standards. This leads to unmatched built quality, but also exceptional value given their actual performance, durability and longevity.

Our shading solutions address the diverse needs of private users and professionals alike. They have been recognized and enjoyed in many countries around the globe, with exports accounting for a constantly growing part of our business.

Whatever your aesthetic preferences are, whatever the requirements of your space may be, whatever the technical challenges, your ideal shading solution exists and you can find it here.



What makes us different

Complete solutions for
professionals & private users
Constant Innovation
Design & Aesthetics
Superior production quality
Quality Assurance
5 Years Warranty
Endurance
Easy Installation

Textile partners

IRISUN  TEXOUT

Automation partners

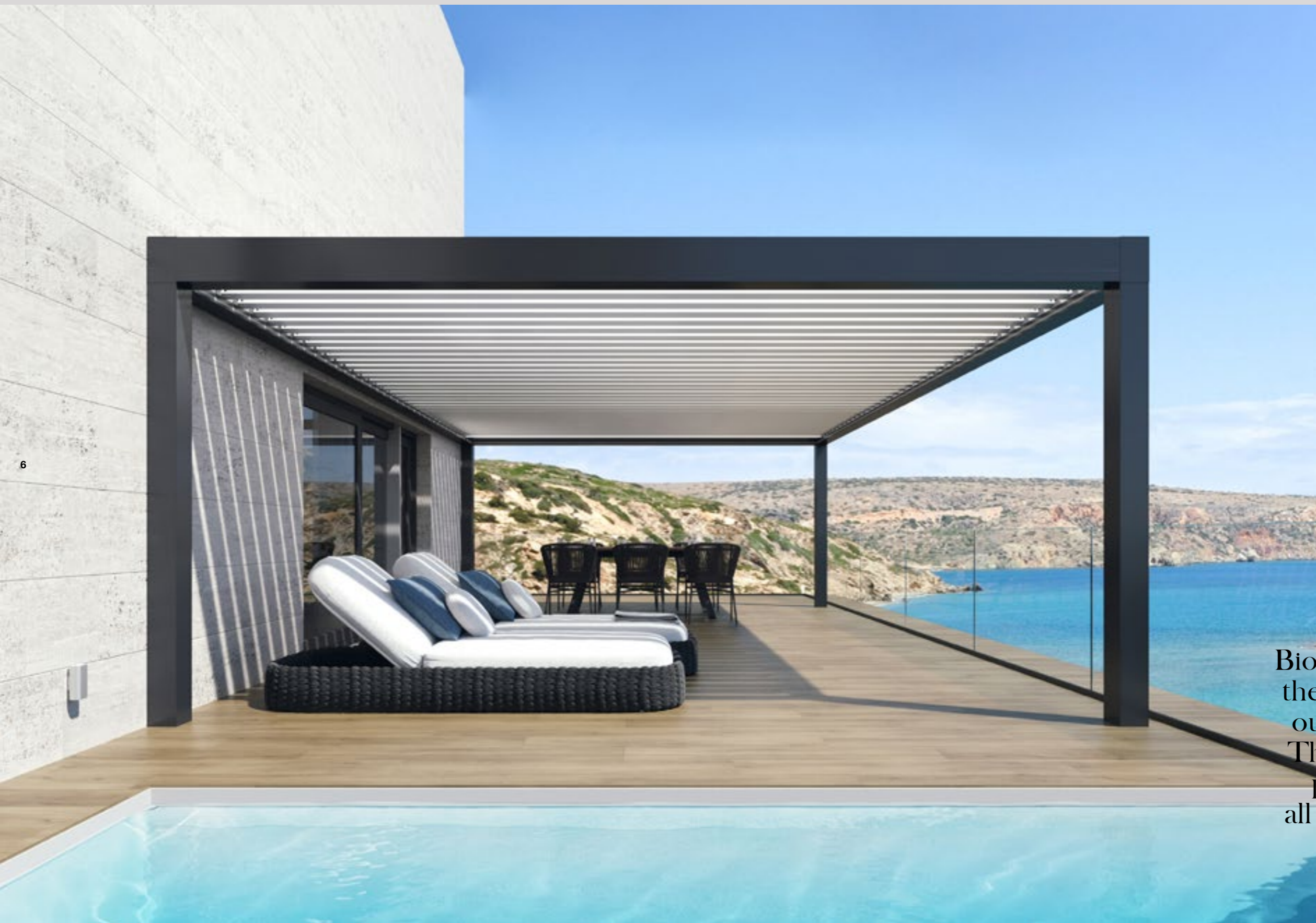

Bioclimatic pergolas are the ideal upgrade your outdoor space needs. They provide optimal protection against all weather conditions.

The superior,
natural solution

This is the solution your outdoors deserve. The Biopergosun pergola is made entirely of durable aluminum, with flexible louvers that rotate from 0 to 130 degrees. Biopergosun provides optimal protection against all weather conditions while making the most of natural energy sources.





Biopergosun

Functionality and technology

Create a contemporary, attractive space while making the most out of natural energy sources.

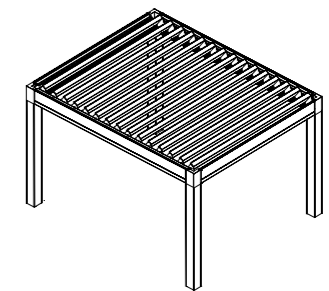

Unmatched comfort & wellness

The extension of your home when you want to, or an outdoor haven whenever you feel like it. Either way, this is a top comfort environment where every moment counts. This is your own oasis, and it is here to be enjoyed moment by moment. Go ahead!



Versatile and impactful outdoor lighting

Choosing the right lighting can make all the difference in the world. Choose one of the almost infinite LED lighting configurations that we offer, and adapt the atmosphere of your space exactly to your needs. You can also play around with the settings, adjusting the lighting to suit the moment and mood. The result is always a guaranteed stunner.

14



15



Biopergosun

MAX 500 CM X 720 CM X 250 CM HIGH

Characteristics

- Maximum dimensions: 500 x 720 cm
- Standard column height: 250 cm
- Column dimensions: 130 x 130 cm
- Configurations: self standing
- motor by Timotion with Somfy receiver
- Integrated rain gutter
- Remote controls and automations: Somfy IO

Dimensions

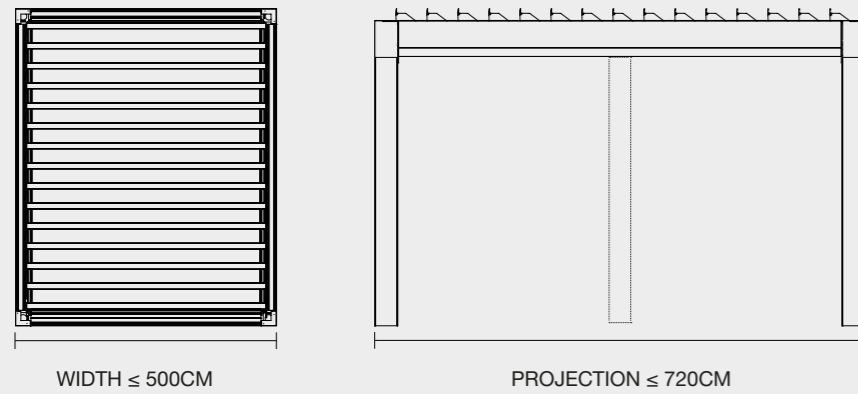

Movement



Finishing color

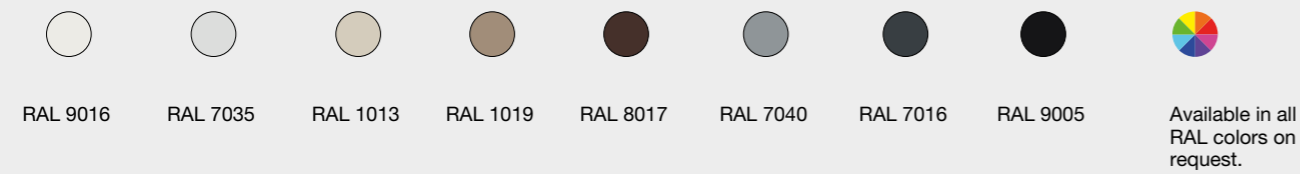

*Other finishes also available include anodized, sable, matt RALs, metallic RALs, glossy RAL, super-durable grain, grain RALs, wood-type, and super durable Sahara cosmos.

Composition

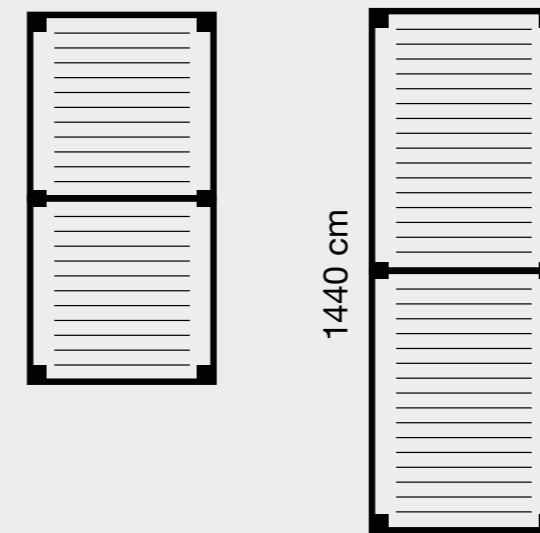
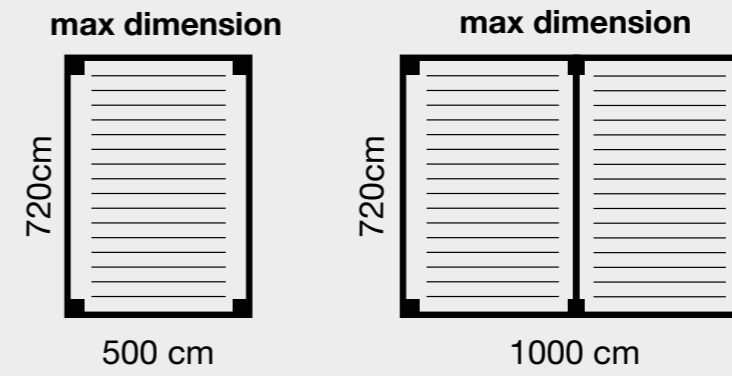

Biopergosun wall

Minimal design and modularity

Ideal for enriching
the design of terraces
and small gardens

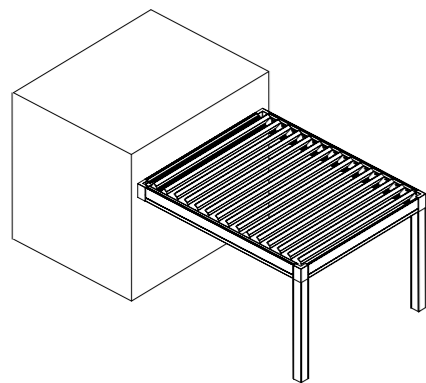

Advanced Aesthetics

Create a uniquely attractive space for your outdoors, just as you imagine it – no compromises are accepted. With its contemporary, clean design, Biopergosun is the ideal upgrade your outdoor space requires. Transformation is under way.

Biopergosun wall

MAX 500 CM X 720 CM X 250 CM HIGH

Characteristics

- Maximum dimensions: 500 x 720 cm
- Standard column height: 250 cm
- Column dimensions: 130 x 130 cm
- Configurations: wall mounted
- motor by Timotion with Somfy receiver
- Integrated rain gutter
- Remote controls and automations: Somfy IO

Dimensions

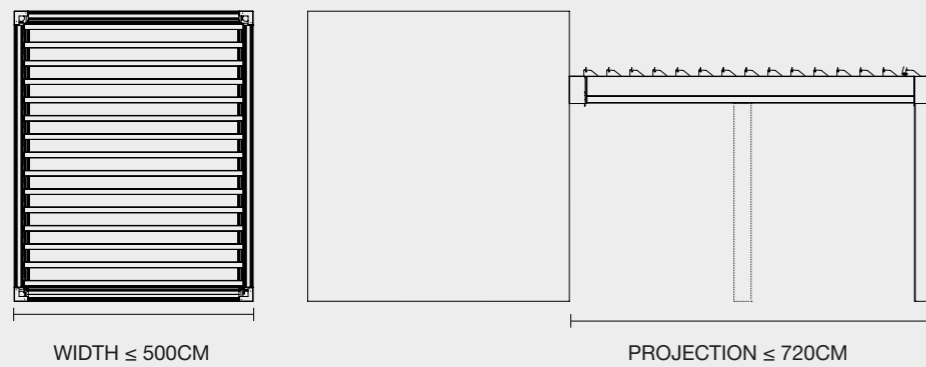

Movement

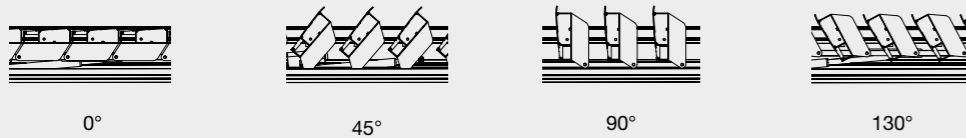

Finishing color

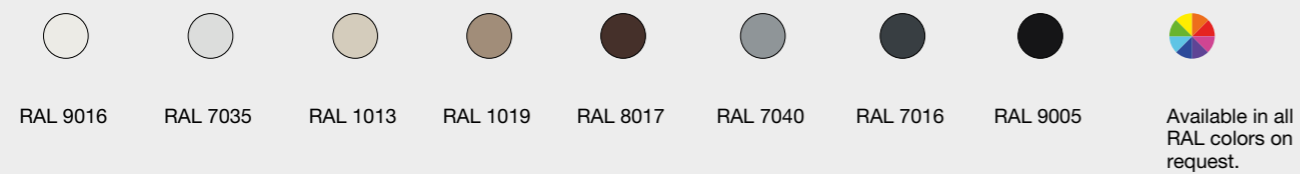

Composition

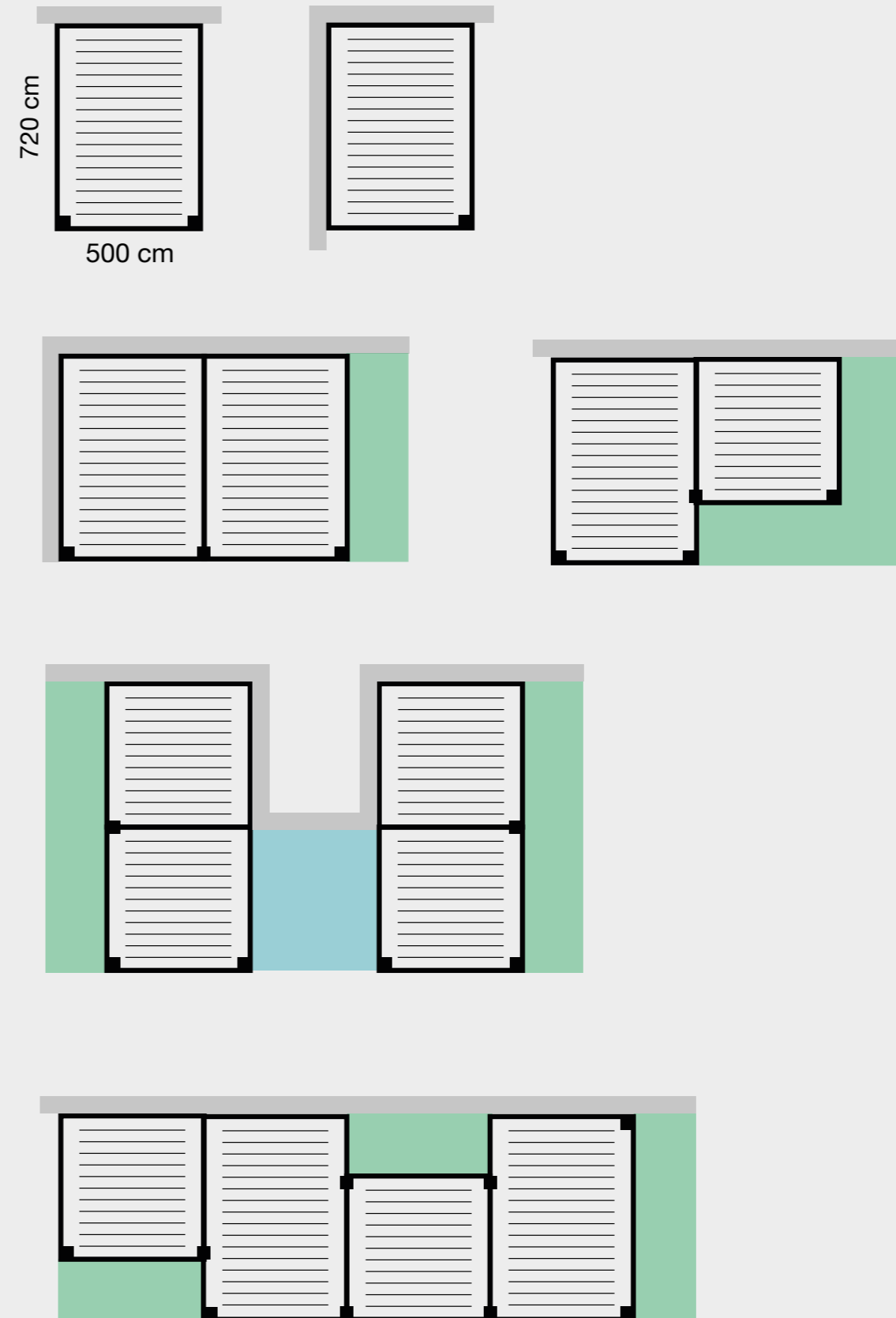

Biopergosun roof

Essential and clean line

Exceptional load resistance
and the ability to cover even
quite large areas

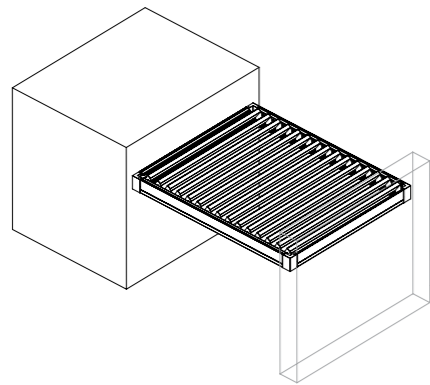

Louvresystem

Biopergosun roof

MAX 500 CM X 720 CM

Characteristics

- Maximum dimensions of the single section: 500x720 cm
- Configurations: upper section without columns
- Standard movement: motor by Timotion with Somfy receiver.
- Remote controls and automations: Somfy IO

Dimensions

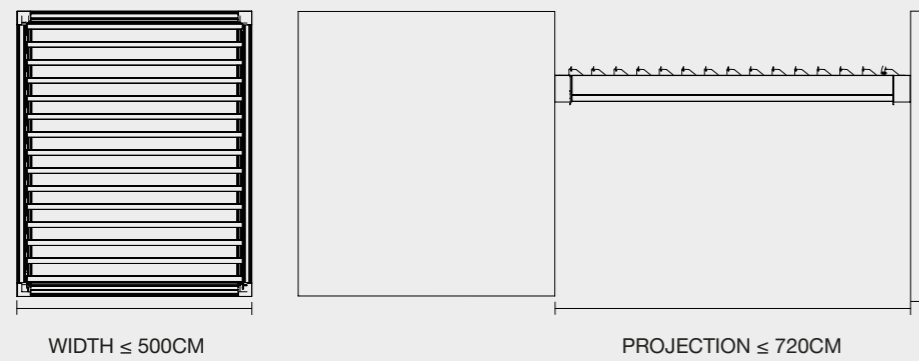

Movement

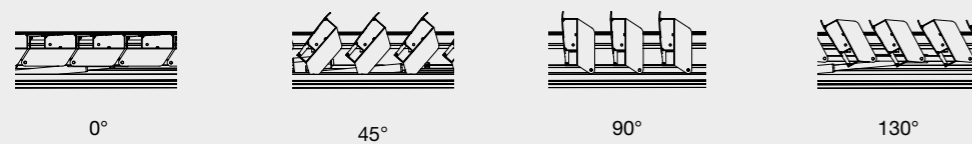

Finishing color

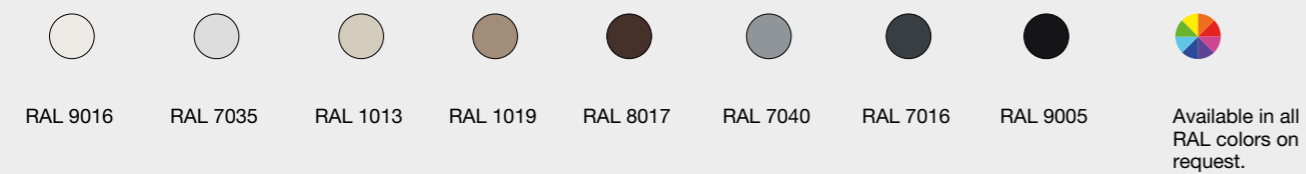

*Other finishes also available include anodized, sable, matt RALs, metallic RALs, glossy RAL, super-durable grain, grain RALs, wood-type, and super durable Sahara cosmos.

Composition

max dimension

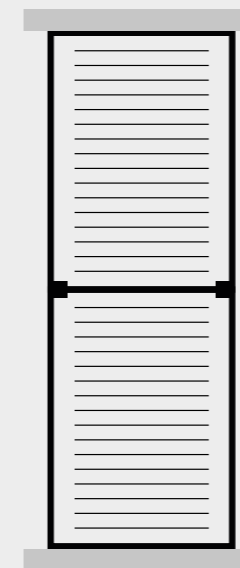
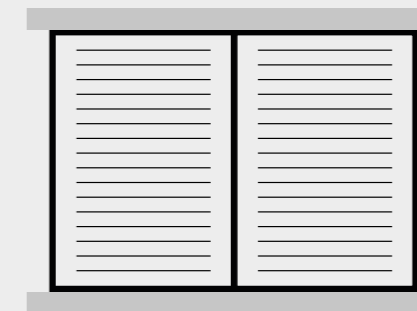
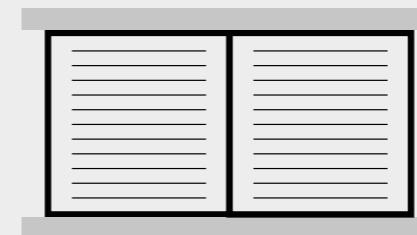
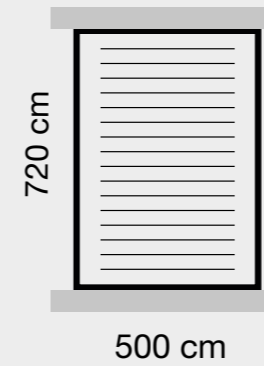

Pergosun

Contemporary, minimalistic and ergonomic

For a modern, ergonomically designed pergola look no further. Pergosun combines high-grade aluminum and retractable, waterproof cloth with a high level of UV protection.





30

31

Durability & Luxury

The materials used in the Pergosun series are selected following extensive research, paying attention to every single detail. The result is an unmatched level of quality and a sense of luxury that can not be found elsewhere.

Absolute Customization

Pergosun stands out with its simple lines and clean surfaces. It can be installed easily and quickly and fits perfectly in any space – including spaces with unusual and demanding dimensions or shapes. The endless choice of frame and cloth colors ensures that the result matches the aesthetics of any environment.



Selected fabrics that combine design and high performance

The fabrics used in our pergolas come exclusively from GIOVANARDI Italy, one of the leading companies in their field, which is ranked among the top in the world. The result? Superiority that can be felt at every level – manufacturing and welding quality, visual comfort, ultimate thermal and UV protection, easy maintenance and unparalleled longevity. On the top of these, there is an impressive range of colors and textures available, in position to satisfy every need and taste – and guarantee an impeccable aesthetic effect.

Pergosun

MAX 1300 CM X 650 CM X 250 CM

Characteristics

- Maximum dimensions: 1300 x 650 cm
- Standard column height: 250 cm
- Column dimensions: 130 x 130 cm
- Configurations: wall mounted
- Somfy IO or RTS
- Fabric type: standard tension fabric
- Integrated rain gutter
- Fabric options: TEXOUT and Serge Ferrari

Dimensions

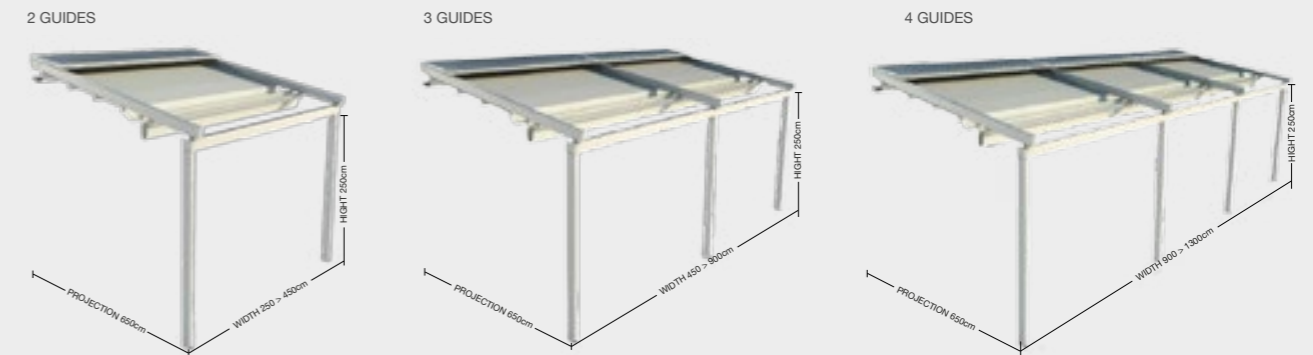

Finishing color

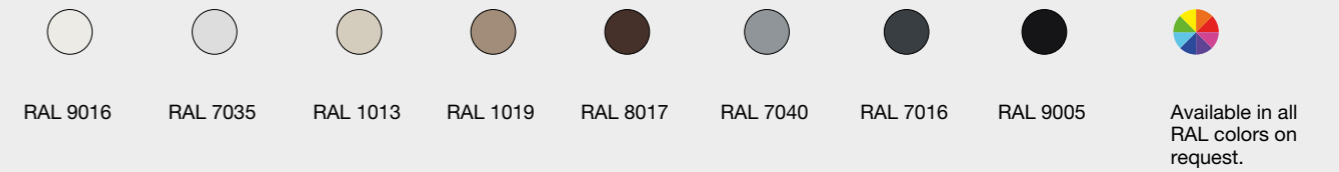

*Other finishes also available include anodized, sable, matt RALs, metallic RALs, glossy RAL, super-durable grain, grain RALs, wood-type, and super durable Sahara cosmos.

Fabrics

TEXOUT

Precontraint 302

Opatex Pro

Opatex Way

Serge Ferrari

Soltis W96



> Discover all Sevensun colors in Fabrics Collection catalog

Optionals

Infrared heaters with a modern design, for indoor & outdoors applications. Effective heating solutions for those who appreciate an elegant environment and comfortable warmth. Heatscope provides highly efficient heating combined with a very low light output, hence conserving energy.

In this newly developed proposition for radiant heaters, light is nothing but an inconspicuous by-product of heat generation. Here, two carbon fiber spirals are charged with an electrical current, beginning to glow and heat up. So alongside the immediately noticeable rise of temperature, there is a subtle, orange-colored ambient light that adds to the environment.

Heatscope® Pure



Characteristics

- The Heatscope® Pure is the only radiant heater worldwide fitted with a convex Schott Nextrema® glass front. The glass primarily fulfills a technical purpose: thanks to its curvature, the carbon-heating elements are located directly at the front and emit even more heat in the A-shaped heating corridor underneath – while emitting significantly less light in the process.
- The Heatscope® Pure comes with a new, colorful fitted bracket for ceiling or wall mounting. The included wall or ceiling bracket requires only two screws to be attached securely. Following that, the radiator is held in place only by a clamping rail. On the back of the casing there is a nut, which is used to clamp it. Finally, the radiator can be oriented to the desired angle using the swivel joint. This saves time, increases flexibility and is more elegant visually.
- The Heatscope® Pure is connected with an IP65 protection class power connector with a 4-pole lead.

Specifications

ON/OFF + two manually adjustable output levels (100% and 50%) on the appliance or externally (integratable to Smart Home Systems such as Somfy, Elsner, KNX etc.)
 Convex black or white front screen.
 Black or white coated aluminum body.
 High performance industrial glass ceramic Schott Nextrema®.
 Energy-efficient double carbon heating elements directly behind the curved glass front.
 Patented reflector heating system with ventilated back.
 Visible light: <300 Lumen.
 Maximum output reached in only 20 seconds.



reddot design award
winner 2018



Automations



Controls

Remote controls for one or more devices, remotes with centralized control, with timer function, or home automation boxes. Discover the remote control that suits you and your pergola!



Wind sensors

Wind sensor: use a sensor to automatically retract your pergola in strong winds, adapting it to climatic conditions.



Sun and wind sensors

Sun and wind sensor to extend or retract the pergolas as the sun comes out or goes in, with priority to retracting them when wind speeds exceed a preset value (from 10 to 50 kph). Prevents fabric from being torn and prolongs the life of the pergola.



TaHoma Switch

From the touch of a button, to app control, all the way to voice control, TaHoma switch offers an accessible to all and scalable smart home solution.

Performance and certifications

Protection



UV PROTECTION



WATER RESISTANT



WIND RESISTANCE



SUN PROTECTION



FIRE RESISTANCE

Materials



FULL INOX



ALUMINUM

Accessories



LED LIGHTS

Certification



CE MARKING



WIND RESISTANCE CERTIFICATION



5 YEARS WARRANTY

Information



SUPPORT & COUNSELLING

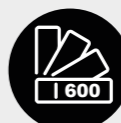

COLOR AVAILABILITY



sevensun

42, Katsimpa Str. 173 42
Ag. Dimitrios,
Athens Greece
T +30 210 9904030
info@sevensun.design
sevensun.design